

# FAG

## **E1 – THE NEW STANDARD FOR SPHERICAL ROLLER BEARINGS**

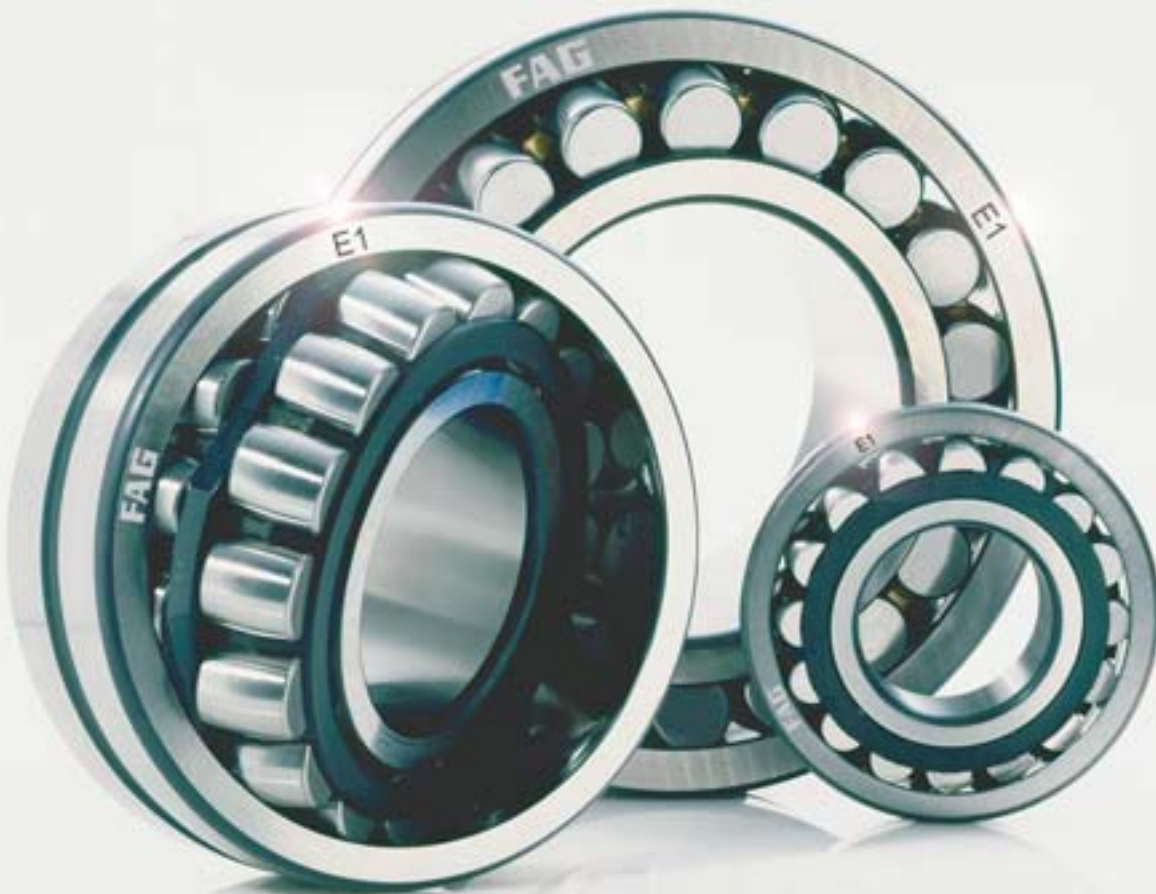

Greater cost effectiveness and operational reliability

# CONTENTS

## **FAG E1 spherical roller bearings: greater cost effectiveness and operational reliability**

**P. 2**

Advantages of the E1 design P. 2

## **FAG E1 spherical roller bearing program**

**P. 3**

## **Characteristics of the E1 spherical roller bearing**

**P. 4**

Standards	<u>P. 4</u>
Basic designs	<u>P. 4</u>
Alignment	<u>P. 4</u>
Tolerances	<u>P. 4</u>
Bearing clearance	<u>P. 5</u>
Lubricating groove, lubricating holes	<u>P. 5</u>
Speed suitability	<u>P. 5</u>
Temperature limit of application	<u>P. 5</u>
Tapered bore	<u>P. 5</u>
Cages	<u>P. 6</u>
Equivalent dynamic load	<u>P. 6</u>
Equivalent static load	<u>P. 6</u>
Minimum load	<u>P. 7</u>
Axial load carrying capacity	<u>P. 7</u>
Vertical shafts	<u>P. 7</u>
Suffixes	<u>P. 7</u>
Abutment dimensions	<u>P. 7</u>

## **E1 Spherical roller bearing applications**

**P. 8**

## **Accessories**

**P. 8**

## **FAG products for mounting, maintenance and monitoring**

**P. 9**

## **Dimensions and performance data**

**P. 10**

# FAG E1 SPHERICAL ROLLER BEARINGS

## Advantages

### FAG E1 spherical roller bearings: greater cost-effectiveness and operational reliability

For more than two decades, FAG E design spherical roller bearings have been successfully used in all kinds of applications where heavy loads have to be accommodated, or where shaft deflections or misalignment of bearing seats must be compensated for. To allow for higher capacity, the basic E design spherical roller bearings do not have a center lip on the inner ring. In order to maintain this high capacity, the new E1 bearings were modelled after this basic design.

There have been new findings in the field of bearing kinematics, improved production processes and better materials. FAG incorporated these new possibilities in the development of the E1 design. The

E1 design provides an even higher radial and axial load carrying capacity and lower bearing temperatures along with improved safety against ring fracture, which increases both the operational reliability and the cost effectiveness of the bearing. The new E1 design covers the entire range of the previous E design.

### So we can offer our customers increased cost effectiveness.

#### Advantages of the E1 design

- **Bearings of a greater capacity:**  
**Longer service life** is achieved through considerably higher dynamic load ratings than those reached before (see diagram)  
**Greater static safety** is gained due to higher static load ratings. This is made possible by improved roller quality and opti-

mized roller geometry. Under identical operating conditions, these bearings clearly have a longer service life. In newly built machines, smaller bearings match the performance of the previously used larger bearings. This permits downsizing and consequently a more cost-effective bearing (smaller space, less friction, less lubricant consumption, higher speeds).

- **Reduced operating costs:**

Due to improved bearing kinematics and higher quality rollers and raceways, less friction and lower bearing temperatures are generated. Consequently, the lubricant is subjected to less strain.

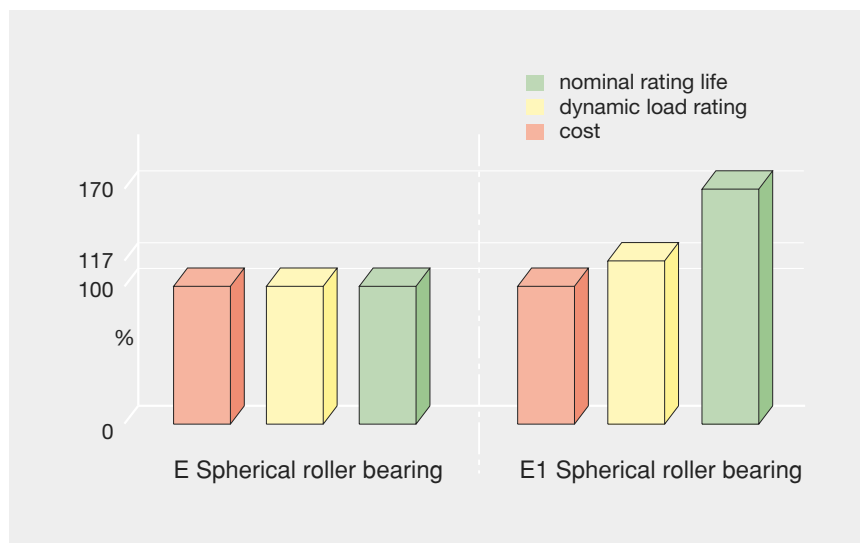

# Program

## FAG E1 spherical roller bearing program

The FAG E1 spherical roller bearing program consists of eight series. The smallest bore diameter is 20 mm and the largest outside diameter is 320 mm.

Narrow bearings with a low cross section, e.g. series 230, are suitable

for high speeds and require little mounting space. By contrast, wide bearings with a high cross section, e.g. series 223, offer a very high load carrying capacity.

E1 Spherical roller bearings are available with both cylindrical and tapered bores. Consequently, the bearings can be mounted on a shaft in several ways.

For particularly punishing operating conditions we offer special designs of E1 spherical roller bearings. For example, where vibratory stresses have to be accommodated, special spherical roller bearings in the 223E1 series with narrow dimensional tolerances and an increased radial clearance are used. These bearings have a T41A suffix.

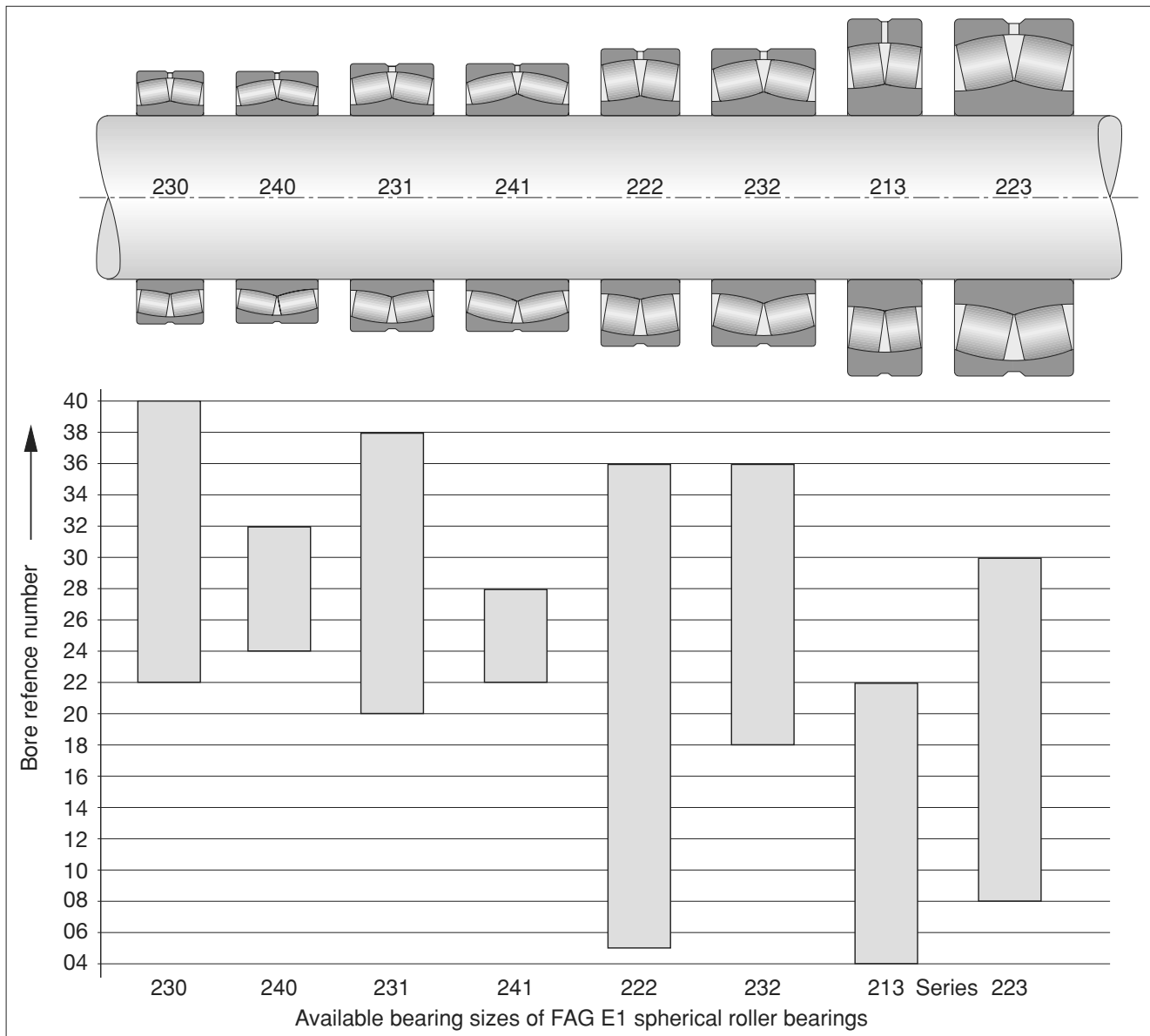

# CHARACTERISTICS OF E1 SPHERICAL ROLLER BEARINGS

## Standards • Basic Designs • Alignment • Tolerances

### Characteristics of spherical roller bearings E1

FAG E1 spherical roller bearings are made for heavy-duty applications. They feature two rows of symmetrical barrel rollers, which can align freely in the spherical outer ring raceway, thus compensating for shaft deflections and misalignment of the bearing seats.

E1 Spherical roller bearings incorporate a maximum number of long rollers with a large diameter. The close contact between the rollers and raceways yields a uniform stress distribution and a high load carrying capacity.

### Standards

E1 Spherical roller bearings meet the requirements of DIN 635-2 and can replace the E spherical roller bearing design.

### Basic designs

Most spherical roller bearings with an outside diameter of up to 320 mm are of the new E1 design. Unlike other spherical roller bearings, these bearings have no center lip on the inner ring, therefore their rollers are longer. Consequently, the load ratings of E1 design bearings are distinctly higher than those of conventional spherical roller bearings.

FAG spherical roller bearings come with either a cylindrical or a tapered bore. Spherical roller bearings with a tapered bore are fixed on the shaft preferably with an adapter or withdrawal sleeve.

### Alignment

Under normal operating conditions and with a rotating inner ring, spherical roller bearings can com-

pensate for misalignments of up to 0.5° out of the center position. If the loads are low ( $P/C < 0.1$ ), angular misalignments of up to 2° are admissible in a corresponding surrounding structure. With a rotating outer ring or wobbling inner ring, slightly smaller alignments are possible. Please contact us for more detailed information.

### Tolerances

FAG spherical roller bearings are made with the normal tolerances of radial bearings (no suffixes for tolerances).

FAG special spherical roller bearings with specification T41A (design for vibratory stressing) with a cylindrical bore have narrow tolerances for bore and outside diameter, see table below. With tapered bore bearings the reduced tolerance range applies only to the outside diameter.

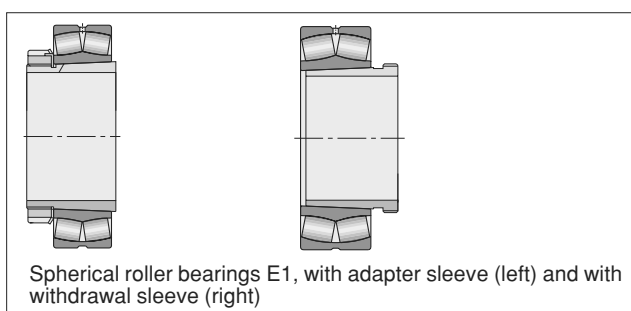
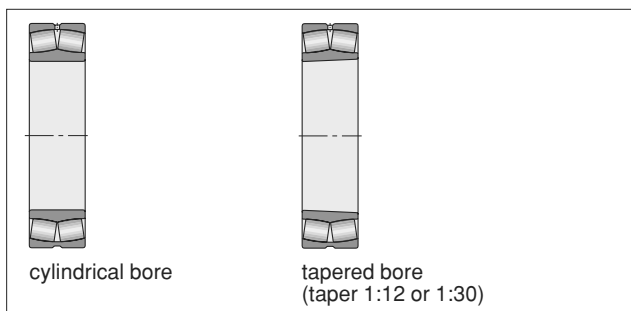

Inner ring		Dimensions in mm			
Nominal bore diameter	over to	30 50	50 80	80 120	120 180
Tolerances in $\mu\text{m}$					
Deviation $\Delta_{\text{dmp}}$		0 -7	0 -9	0 -12	0 -15
Outer ring		Dimensions in mm			
Nominal outside diameter	over to	80 150	150 180	180 315	315 400
Tolerances in $\mu\text{m}$					
Deviation $\Delta_{\text{Dmp}}$		-5 -13	-5 -18	-10 -23	-13 -28
Narrow tolerances with FAG specification T41A					

## Bearing clearance • Lubricating groove • Speed suitability • Temperature limit of application • Tapered bore

### Bearing clearance

The basic design of our spherical roller bearing is made with a “normal” clearance CN (no suffixes for the bearing clearance are used). To account for varying operating and mounting conditions, we supply, on request, bearings with an increased clearance. The suffixes are C3 for a radial clearance larger than normal and C4 for a radial clearance larger than C3. Spherical roller bearings with the T41A specification have a C4 clearance.

### Lubricating groove, lubricating holes

FAG spherical roller bearings have a lubricating groove and three lubricating holes in the outer ring to simplify lubrication. This also applies to the 213E1 series except for the four smallest sizes.

The lubricating groove and lubricating holes are not identified by a

suffix, as was the case with the 222E and 223E series.

### Speed suitability

Under appropriate operating conditions, the reference speed specified in the bearing tables may be exceeded up to the value of the limiting speed. Special operating conditions are taken into consideration by determining the thermally permissible operating speed (see catalogue WL 41 520).

### Temperature limit of application, heat treatment

FAG spherical roller bearings are heat treated so they can be used at operating temperatures of up to 200 °C. If bearings with a polyamide cage are used, the temperature limit of the cage has to be observed.

The inner rings of all E1 spherical roller bearings are bairnically hardened, (FAG Isotemp harden-

ing) to withstand particularly punishing operating conditions.

### Tapered bore

Most series of FAG spherical roller bearings are also available with a tapered bore. The suffix K identifies a 1:12 taper. Only the spherical roller bearing series 240 and 241 have a 1:30 taper (suffix K30). Bearings with a tapered bore are typically fastened on the shaft with adapter sleeves or withdrawal sleeves.

Larger sleeves feature oil feed holes and grooves so that they can be mounted hydraulically. The extraction nuts used with the withdrawal sleeves have to be listed separately when placing an order (see p. 8).

The table shows how the radial clearance is reduced when spherical roller bearings with a tapered bore are mounted. The indicated values ensure a tight fit on the shaft.

Radial clearance reduction in spherical roller bearings with a tapered bore (solid shaft)

Nominal bearing bore		Reduction of radial clearance		Axial displacement on taper 1:12				Axial displacement on taper 1:30				Check values for the smallest radial clearance after mounting		
d over mm	to	min mm	max	Shaft min mm	max	Sleeve min	max	Shaft min mm	max	Sleeve min	max	CN min mm	C3 min	C4 min
24	30	0.015	0.02	0.3	0.35	0.3	0.4					0.015	0.02	0.035
30	40	0.02	0.025	0.35	0.4	0.35	0.45					0.015	0.025	0.04
40	50	0.025	0.03	0.4	0.45	0.45	0.5					0.02	0.03	0.05
50	65	0.03	0.04	0.45	0.6	0.5	0.7					0.025	0.035	0.055
65	80	0.04	0.05	0.6	0.75	0.7	0.85					0.025	0.04	0.07
80	100	0.045	0.06	0.7	0.9	0.75	1	1.7	2.2	1.8	2.4	0.035	0.05	0.08
100	120	0.05	0.07	0.7	1.1	0.8	1.2	1.9	2.7	2	2.8	0.05	0.065	0.1
120	140	0.065	0.09	1.1	1.4	1.2	1.5	2.7	3.5	2.8	3.6	0.055	0.08	0.11
140	160	0.075	0.1	1.2	1.6	1.3	1.7	3	4	3.1	4.2	0.055	0.09	0.13
160	180	0.08	0.11	1.3	1.7	1.4	1.9	3.2	4.2	3.3	4.6	0.06	0.1	0.15
180	200	0.09	0.13	1.4	2	1.5	2.2	3.5	4.5	3.6	5	0.07	0.1	0.16

# CHARACTERISTICS OF E1 SPHERICAL ROLLER BEARINGS

## Cages • Equivalent load

### Cages

Spherical roller bearing series 222E1 and 223E1 without a cage suffix are fitted with pressed steel cages. A guiding ring in the outer ring retains the two cage halves. All parts of the cages for the basic bearing designs of series 223E1 and for bearings with the T41A specification are surface-hardened; in some bearings the guiding rings are nickel-coated. E1 spherical roller bearings with machined brass cages have an M suffix.

Spherical roller bearings with molded cages of glass-fibre reinforced polyamide have a TVPB suffix. These cages are suitable for applications with stable temperatures of up to 120 °C. If the bearings are lubricated with oil, any additives contained in the oil may reduce the cage service life. Also, aged oil can reduce the cage life at higher temperatures; therefore, the oil change intervals must be observed.

### Equivalent dynamic load

$$P = F_r + Y \cdot F_a \quad [\text{kN}] \text{ for } F_a/F_r \leq e$$

$$P = 0.67 \cdot F_r + Y \cdot F_a \quad [\text{kN}] \text{ for } F_a/F_r > e$$

Y and e are indicated in the bearing tables.

### Equivalent static load

$$P_0 = F_r + Y_0 \cdot F_a \quad [\text{kN}]$$

The thrust factor  $Y_0$  is indicated in the bearing tables.

### Standard cages for FAG E1 spherical roller bearings

#### Pressed steel cages

outer ring guided

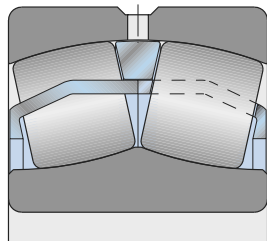

#### Molded polyamide cages

inner ring guided

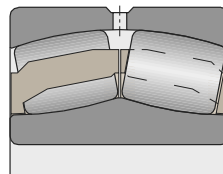

#### Machined brass cages

roller riding

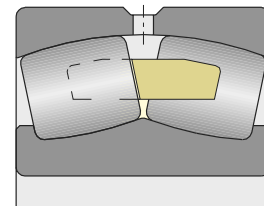

Cage suffix

–

TVPB

M

Series (design)

Bore reference number

213E1

222E1

223E1

up to 36

up to 30

up to 22

223E1(T41A)

230E1

230E1A

up to 30

up to 40

up to 40

231E1

231E1A

232E1

up to 38

up to 36

up to 38

232E1A

240E1

241E1

up to 32

up to 28

up to 36

## Minimum load • Axial load carrying capacity • Vertical shafts • Suffixes • Abutment dimensions

### Minimum load

We recommend the following minimal load for FAG E1 spherical roller bearings:

$$P = 0.015 C \text{ [kN]}$$

C dynamic load rating [kN], see bearing tables

### Axial load carrying capacity

FAG spherical roller bearings are also suitable for high thrust loads. If high loads combined with high speeds have to be accommodated, increased friction and the higher bearing temperatures that are generated must be taken into account. Please contact us for more specific information.

### Vertical shafts

If vertical shafts are supported in spherical roller bearings, a reliable lubricant supply must be ensured. In such cases we recommend oil lubrication.

### Suffixes

E1 maximum capacity design  
 K tapered bore, taper 1:12  
 K30 tapered bore, taper 1:30  
 M machined brass cage, roller riding

TVPB molded window-type cage of polyamide, inner ring guided  
 T41A special design for vibratory stressing, with narrow tolerances, radial clearance C4

Commonly used combinations of suffixes:

E1K maximum capacity design, tapered bore (taper 1:12)  
 E1A.M maximum capacity design, machined brass cage, roller riding  
 E1AK.M maximum capacity design, tapered bore (taper 1:12), machined brass cage, roller riding  
 E1TVPB maximum capacity design, molded cage of glass-fibre reinforced polyamide, inner ring guided  
 E1K.TVPB maximum capacity design, tapered bore (taper 1:12), molded cage of glass-fibre reinforced polyamide, inner ring guided  
 E1.T41A maximum capacity design, special design for vibratory stressing, with narrow tolerances, radial clearance C4  
 E1K.T41A maximum capacity design, tapered bore (taper 1:12), special design for vibratory stressing, with narrow tolerances, radial clearance C4

### Abutment dimensions

The bearing table lists the maximum fillet radius  $r_g$  and the diameters of the abutment shoulders. To ensure perfect operation of the spherical roller bearing, the abutment dimensions must not be smaller than H and not larger than  $J_1$ . Due to a modified internal design, the abutment dimensions of spherical roller bearings 21308E1 to 21318E1 differ from those of the previously used bearings. If spherical roller bearings with an adapter sleeve are installed, the dimensions of the back-up ring have to be taken into account.

## APPLICATIONS • ACCESSORIES

### E1 Spherical roller bearing applications

In construction machines, gearboxes, mining machinery, conveyors, ship propulsion and rudder engines, rolling mills and hoisting equipment, in all applications where utmost load carrying capacity and a long service life are required or the most punishing environmental conditions - FAG E1 spherical roller bearings are the best choice.

Depending on the type of application, spherical roller bearings have to meet a variety of requirements. For example, rudder bearings, which perform only slight, slewing motions, must feature a high static load carrying capacity.

Spherical roller bearings in the dryer section of a paper machine must withstand high speeds and high temperatures.

In vibrating screens, bearings must accommodate not only high loads

and high speeds but also extreme acceleration. A special spherical roller bearing design with narrow tolerances and an increased radial clearance (FAG specification T41A) meets these requirements.

Mining machines, processing equipment and construction machines require bearings that can accommodate extremely high loads, and often impact loads. In order to build cost-effective gears, the high radial load carrying capacity, the axial load carrying capacity and the self-aligning capability of spherical roller bearings are often used.

### Accessories

FAG E1 spherical roller bearings are combined with FAG fastening elements, housings and Arcanol rolling bearing greases from FAG to form assemblies that are optimally matched to each other.

FAG **adapter sleeves** and **with-**

**drawal sleeves** simplify the mounting and dismounting of spherical roller bearings with tapered bores considerably.

**Locknuts** are used to fix the E1 spherical roller bearings directly on the shaft or on an adapter sleeve. Locknuts are also useful for mounting and dismounting bearings on withdrawal sleeves or on tapered shaft journals.

FAG **housings** and the bearings mounted into them have successfully been used in countless machines, installations and equipment. Numerous housing series, as well as the fastening elements referred to above, are described in our catalogue WL 41 520 "FAG Rolling Bearings". In addition, we offer special housings that are designed for special requirements.

For detailed information on FAG Arcanol **rolling bearing greases**, see FAG Publ. No. WL 81 116.



by FAG

## PRODUCTS FOR MOUNTING, MAINTENANCE AND MONITORING

### FAG products for mounting, maintenance and monitoring

In order to fully utilize the high capacity of the FAG E1 spherical roller bearings, correct mounting and dismounting, lubrication and sealing, as well as maintenance are extremely important. Monitoring rolling bearings makes sense and is cost-effective with applications where a production loss can be very expensive.

The methods used for mounting and dismounting the bearings are described in detail in FAG Publ. No. WL 80 100, "Mounting and Dismounting of Rolling Bearings". An overview of suitable FAG tools and measuring devices as well as diagnosis devices is provided by FAG Publ. No. WL 80 250 "FAG Mounting and Maintenance Equipment and Services for Rolling Bearings". They include, for example, induction heating devices, extrac-

tors, hydraulic nuts, hand pump sets, feeler gauges, temperature measuring instrument as well as vibration diagnosis devices. The brochure also contains descriptions of FAG Arcanol greases, which have already been successfully used in numerous spherical roller bearing applications and in automatic lubricators.



# FAG SPHERICAL ROLLER BEARINGS E1

## with cylindrical and tapered bores

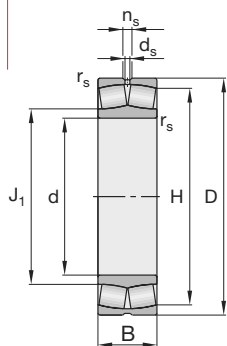

cylindrical bore

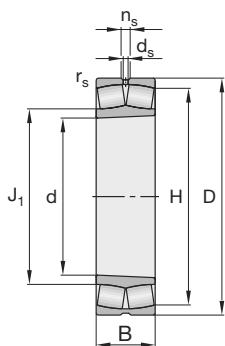

tapered bore

Shaft	Dimensions					$J_1$ ≈	$n_s$	$d_s$	Mass ≈ kg	Code Bearing FAG
	d mm	D	B	$r_s$ min	H ≈					
20	20	52	15	1.1	43	28.9			0.16	21304E1TVPB
25	25	52	18	1	44.5	31.3	4.8	3.2	0.18	22205E1
	25	62	17	1.1	51	35.2			0.25	21305E1TVPB
30	30	62	20	1	53.7	37.9	4.8	3.2	0.27	22206E1
	30	72	19	1.1	59.9	41.5			0.39	21306E1TVPB
35	35	72	23	1.1	62.5	43.8	4.8	3.2	0.43	22207E1
	35	80	21	1.5	66.6	47.4			0.5	21307E1TVPB
40	40	80	23	1.1	70.3	48.6	4.8	3.2	0.528	22208E1
	40	90	23	1.5	80.8	59.7	4.8	3.2	0.7	21308E1TVPB
	40	90	33	1.5	76	52.4	4.8	3.2	1.05	22308E1
45	45	85	23	1.1	75.6	54.8	4.8	3.2	0.589	22209E1
	45	100	25	1.5	89.8	67.3	4.8	3.2	0.845	21309E1TVPB
	45	100	36	1.5	84.7	58.9	6.5	3.2	1.39	22309E1
50	50	90	23	1.1	80.8	59.7	4.8	3.2	0.622	22210E1
	50	110	27	2	89.8	67.3	4.8	3.2	0.845	21310E1TVPB
	50	110	40	2	92.6	63	6.5	3.2	1.9	22310E1
55	55	100	25	1.5	89.8	67.3	4.8	3.2	0.85	22211E1
	55	120	29	2	98.3	71.4	6.5	3.2	1.19	21311E1TVPB
	55	120	43	2	101.4	68.9	6.5	3.2	2.27	22311E1

Spherical roller bearings E1 - with the exception of sizes 21304E1TVPB to 21306E1TVPB - are also available with a tapered bore, e.g. 22207E1K.

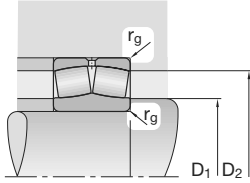

Road rating · Factor dyn. C	e	$F_a/F_r \leq e$ Y	$F_a/F_r > e$ Y	stat. C <sub>0</sub>	Y <sub>0</sub>	Limiting speed min <sup>-1</sup>	Reference speed	Abutment dimensions		
								D <sub>1</sub> min mm	D <sub>2</sub> max	r <sub>g</sub> max
40.5	0.3	2.25	3.34	33.5	2.2	15000	12000	27	45	1
51	0.34	1.98	2.94	45	1.93	17000	11000	30.6	46.4	1
52	0.28	2.43	3.61	43	2.37	13000	10000	32	55	1
68	0.31	2.15	3.2	62	2.1	13000	9500	35.6	54.6	1
72	0.27	2.49	3.71	63	2.43	11000	8500	37	65	1
91.5	0.31	2.16	3.22	83	2.12	11000	8500	42	65	1
83	0.26	2.55	3.8	73.5	2.5	9500	8000	44	71	1.5
104	0.28	2.41	3.59	95	2.35	10000	7500	47	73	1
114	0.24	2.81	4.19	114	2.75	9500	6700	49	81	1.5
156	0.36	1.86	2.77	150	1.82	7500	7000	49	81	1.5
110	0.26	2.62	3.9	106	2.56	10000	6700	52	78	1
140	0.23	2.92	4.35	146	2.86	8500	6300	54	91	1.5
186	0.36	1.9	2.83	183	1.86	6700	6300	54	91	1.5
114	0.24	2.81	4.19	114	2.75	9500	6000	57	83	1
140	0.23	2.92	4.35	146	2.86	8500	6000	61	99	2
228	0.36	1.86	2.77	224	1.82	6000	6000	61	99	2
140	0.23	2.92	4.35	146	2.86	8500	5600	64	91	1.5
170	0.24	2.84	4.23	166	2.78	6300	5600	66	109	2
265	0.36	1.89	2.81	260	1.84	5600	5600	66	109	2

Spherical roller bearings 21304E1TVPB to 21307E1TVPB feature neither lubricating groove nor lubricating holes. Spherical roller bearings 223..E1 are also available as a special design for vibratory stressing, e.g. 22308E1.T41A.

# FAG SPHERICAL ROLLER BEARINGS E1

## with cylindrical and tapered bores

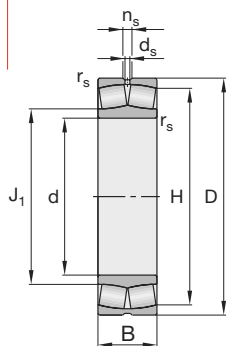

cylindrical bore

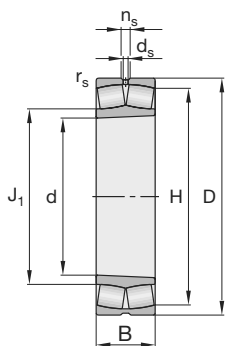

tapered bore

Shaft	Dimensions								Mass ≈ kg	Code Bearing FAG
	d	D	B	r <sub>s</sub> min	H ≈	J <sub>1</sub> ≈	n <sub>s</sub>	d <sub>s</sub>		
	mm									
60	60	110	28	1.5	98.7	71.4	6.5	3.2	1.12	22212E1
	60	130	31	2.1	112.5	84.4	6.5	3.2	1.78	21312E1TVPB
	60	130	46	2.1	110.1	74.8	6.5	3.2	2.89	22312E1
65	65	120	31	1.5	107.3	79.1	6.5	3.2	1.55	22213E1
	65	140	33	2.1	126.8	94.8	6.5	3.2	2.42	21313E1TVPB
	65	140	48	2.1	119.3	83.2	9.5	4.8	3.57	22313E1
70	70	125	31	1.5	112.5	84.4	6.5	3.2	1.65	22214E1
	70	150	35	2.1	126.2	94.9	6.5	3.2	3	21314E1TVPB
	70	150	51	2.1	128	86.7	9.5	4.8	4.21	22314E1
75	75	130	31	1.5	117.7	89.8	6.5	3.2	1.72	22215E1
	75	160	37	2.1	135.1	99.7	6.5	3.2	2.86	21315E1TVPB
	75	160	55	2.1	136.3	92.4	9.5	4.8	5.18	22315E1
80	80	140	33	2	126.8	94.8	6.5	3.2	2.13	22216E1
	80	170	39	2.1	135.4	99.7	6.5	3.2	2.65	21316E1TVPB
	80	170	58	2.1	145.1	98.3	9.5	4.8	6.27	22316E1
85	85	150	36	2	135.4	99.7	6.5	3.2	2.65	22217E1
	85	180	41	3	143.9	106.1	9.5	4.8	5.37	21317E1TVPB
	85	180	60	3	154.2	104.4	9.5	4.8	7.06	22317E1

Spherical roller bearings E1 are also available with a tapered bore, e.g. 21316E1K.TVPB.

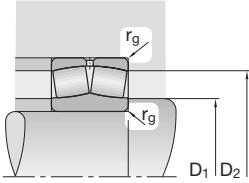

Road rating · Factor dyn. C	e	$F_a/F_r \leq e$ Y	$F_a/F_r > e$ Y	stat. C <sub>0</sub>	Y <sub>0</sub>	Limiting speed min <sup>-1</sup>	Reference speed	Abutment dimensions		
								D <sub>1</sub> min mm	D <sub>2</sub> max	r <sub>g</sub> max
170	0.24	2.84	4.23	166	2.78	7500	5300	69	101	1.5
212	0.23	2.95	4.4	228	2.89	6300	4500	72	118	2.1
310	0.35	1.91	2.85	310	1.87	5000	5000	72	118	2.1
200	0.24	2.81	4.19	208	2.75	6700	5000	74	111	1.5
250	0.22	3.14	4.67	270	3.07	5000	4800	77	128	2.1
355	0.34	2	2.98	365	1.96	4800	4500	77	128	2.1
212	0.23	2.95	4.4	228	2.89	6300	4800	79	116	1.5
250	0.22	3.14	4.67	270	3.07	5000	4800	82	138	2.1
390	0.34	2	2.98	390	1.96	4500	4300	82	138	2.1
216	0.22	3.1	4.62	236	3.03	6300	4500	84	121	1.5
305	0.22	3.04	4.53	325	2.97	4800	4300	87	148	2.1
440	0.34	1.99	2.96	450	1.94	4300	3800	87	148	2.1
250	0.22	3.14	4.67	270	3.07	5600	4300	91	129	2
305	0.22	3.04	4.53	325	2.97	4800	4300	92	158	2.1
500	0.34	1.99	2.96	510	1.94	4300	3600	92	158	2.1
305	0.22	3.04	4.53	325	2.97	5300	4000	96	139	2
345	0.23	2.9	4.31	375	2.83	4800	3800	99	166	2.5
540	0.33	2.04	3.04	560	2	4000	3200	99	166	2.5

Spherical roller bearings 223..E1 are also available as a special design for vibratory stressing, e.g. 22315E1.T41A.

# FAG SPHERICAL ROLLER BEARINGS E1

## with cylindrical and tapered bores

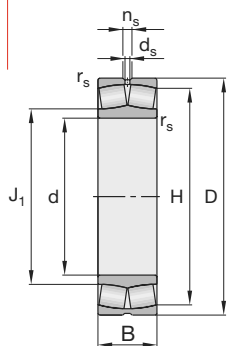

cylindrical bore

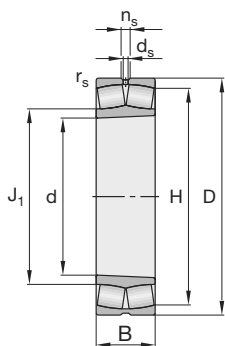

tapered bore

Shaft	Dimensions								Mass ≈ kg	Code Bearing FAG
	d	D	B	r <sub>s</sub> min	H ≈	J <sub>1</sub> ≈	n <sub>s</sub>	d <sub>s</sub>		
	mm									
<b>90</b>	90	160	40	2	143.9	106.1	6.5	3.2	3.43	<b>22218E1</b>
	90	160	52.4	2	140	104.1	6.5	3.2	4.27	<b>23218E1TVPB</b>
	90	160	52.4	2	140		6.5	3.2	4.46	<b>23218E1A.M</b>
	90	190	43	3	152.7	112.6	9.5	4.8	6.26	<b>21318E1TVPB</b>
	90	190	64	3	162.5	110.2	12.2	6.3	8.51	<b>22318E1</b>
<b>95</b>	95	170	43	2.1	152.7	112.6	9.5	4.8	4.13	<b>22219E1</b>
	95	200	45	3	169.4	124.3	9.5	4.8	6.63	<b>21319E1TVPB</b>
	95	200	67	3	171.2	116	12.2	6.3	9.69	<b>22319E1</b>
<b>100</b>	100	165	52	2	146.3	113.9	6.5	3.2	4.22	<b>23120E1TVPB</b>
	100	165	52	2	146.3		6.5	3.2	4.37	<b>23120E1A.M</b>
	100	180	46	2.1	161.4	119	9.5	4.8	4.96	<b>22220E1</b>
	100	180	60.3	2.1	156.6	116.7	9.5	4.8	6.32	<b>23220E1TVPB</b>
	100	180	60.3	2.1	156.6		9.5	4.8	6.45	<b>23220E1A.M</b>
	100	215	47	3	182	132	9.5	4.8	8.19	<b>21320E1TVPB</b>
	100	215	73	3	183.3	124.2	12.2	6.3	12.8	<b>22320E1</b>
<b>110</b>	110	170	45	2	154.6	123.7	6.5	3.2	3.55	<b>23022E1TVPB</b>
	110	170	45	2	154.6		6.5	3.2	3.67	<b>23022E1A.M</b>
	110	180	56	2	160	124.6	9.5	4.8	5.31	<b>23122E1TVPB</b>
	110	180	56	2	160		9.5	4.8	5.51	<b>23122E1A.M</b>
	110	180	69	2	154.8	125.1	6.5	3.2	6.85	<b>24122E1TVPB</b>
	110	200	53	2.1	178.7	129.4	9.5	4.8	6.99	<b>22222E1</b>
	110	200	69.8	2.1	172.7	129.1	9.5	4.8	9.18	<b>23222E1TVPB</b>
	110	200	69.8	2.1	172.7		9.5	4.8	9.54	<b>23222E1A.M</b>
	110	240	50	3	202.5	146.4	12.2	6.3	11.1	<b>21322E1TVPB</b>
	110	240	80	3	204.9	143.1	15	8	17.7	<b>22322E1</b>

Spherical roller bearings E1 are also available with a tapered bore, e.g. 23122E1K.TVPB.

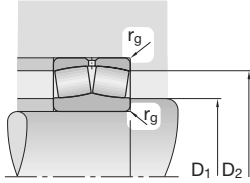

Load rating · Factor dyn. C	e	$F_a/F_r \leq e$ Y	$F_a/F_r > e$ Y	stat. C <sub>0</sub>	Y <sub>0</sub>	Limiting speed	Reference speed	Abutment dimensions		
								D <sub>1</sub> min mm	D <sub>2</sub> max	r <sub>g</sub> max
kN				kN		min <sup>-1</sup>				
345	0.23	2.9	4.31	375	2.83	4800	3800	101	149	2
440	0.31	2.2	3.27	520	2.15	4300	2800	101	149	2
440	0.31	2.2	3.27	520	2.15	4300	2800	101	149	2
380	0.24	2.87	4.27	415	2.8	4500	3600	104	176	2.5
610	0.33	2.03	3.02	630	1.98	3600	3000	104	176	2.5
380	0.24	2.87	4.27	415	2.8	4500	3600	107	158	2.1
430	0.22	3.04	4.53	455	2.97	4000	3400	109	186	2.5
670	0.33	2.03	3.02	695	1.98	3000	2800	109	186	2.5
450	0.28	2.37	3.53	570	2.32	4300	3000	111	154	2
450	0.28	2.37	3.53	570	2.32	4300	3000	111	154	2
430	0.24	2.84	4.23	475	2.78	4300	3400	112	168	2.1
550	0.31	2.15	3.2	655	2.1	3600	2400	112	168	2.1
550	0.31	2.15	3.2	655	2.1	3600	2400	112	168	2.1
490	0.22	3.14	4.67	530	3.07	3600	3200	114	201	2.5
815	0.33	2.03	3.02	915	1.98	3000	2400	114	201	2.5
400	0.23	2.9	4.31	530	2.83	4300	3200	118.8	161.2	2
400	0.23	2.9	4.31	530	2.83	4300	3200	118.8	161.2	2
530	0.28	2.41	3.59	680	2.35	4000	2600	121	169	2
530	0.28	2.41	3.59	680	2.35	4000	2600	121	169	2
620	0.35	1.94	2.88	900	1.89	2600	1800	121	169	2
550	0.25	2.71	4.04	600	2.65	4000	3000	122	188	2.1
710	0.33	2.06	3.06	865	2.01	3000	2200	122	188	2.1
710	0.33	2.06	3.06	865	2.01	3000	2200	122	188	2.1
600	0.21	3.24	4.82	640	3.16	3000	2800	124	226	2.5
950	0.33	2.07	3.09	1060	2.03	2600	2200	124	226	2.5

Spherical roller bearings 223..E1 are also available as a special design for vibratory stressing, e.g. 22320E1.T41A.

# FAG SPHERICAL ROLLER BEARINGS E1

## with cylindrical and tapered bores

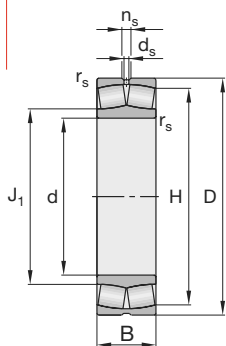

cylindrical bore

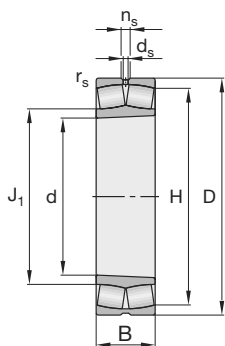

tapered bore

Shaft	Dimensions								Mass ≈ kg	Code Bearing FAG
	d	D	B	r <sub>s</sub> min	H ≈	J <sub>1</sub> ≈	n <sub>s</sub>	d <sub>s</sub>		
	mm									
<b>120</b>	120	180	46	2	164.7	133	6.5	3.2	3.86	<b>23024E1TVPB</b>
	120	180	46	2	164.7		6.5	3.2	4.17	<b>23024E1A.M</b>
	120	180	60	2	160.1	132	6.5	3.2	5.65	<b>24024E1TVPB</b>
	120	200	62	2	177.4	136.2	9.5	4.8	7.39	<b>23124E1TVPB</b>
	120	200	62	2	177.4		9.5	4.8	7.7	<b>23124E1A.M</b>
	120	200	80	2	170.6	136.3	6.5	3.2	11.6	<b>24124E1TVPB</b>
	120	215	58	2.1	192	141.8	12.2	6.3	8.84	<b>22224E1</b>
	120	215	76	2.1	185.5	139	9.5	4.8	11.5	<b>23224E1TVPB</b>
	120	215	76	2.1	185.5		9.5	4.8	12.1	<b>23224E1A.M</b>
	120	260	86	3	222.4	150.8	15	8	22.5	<b>22324E1</b>
<b>130</b>	130	200	52	2	182.3	145.9	9.5	4.8	5.61	<b>23026E1TVPB</b>
	130	200	52	2	182.3		9.5	4.8	5.96	<b>23026E1A.M</b>
	130	200	69	2	176.9	144.7	6.5	3.2	7.72	<b>24026E1TVPB</b>
	130	210	64	2	187.3	146	9.5	4.8	8.11	<b>23126E1TVPB</b>
	130	210	64	2	187.3		9.5	4.8	8.45	<b>23126E1A.M</b>
	130	210	80	2	181.5	146.4	6.5	3.2	10.6	<b>24126E1TVPB</b>
	130	230	64	3	205	151.7	12.2	6.3	11.3	<b>22226E1</b>
	130	230	80	3	199.3	150	9.5	4.8	13.4	<b>23226E1TVPB</b>
	130	230	80	3	199.3		9.5	4.8	14	<b>23226E1A.M</b>
	130	280	93	4	240	162.2	17.7	9.5	28	<b>22326E1</b>

Spherical roller bearings E1 are also available with a tapered bore, e.g. 24126E1K30TVPB.

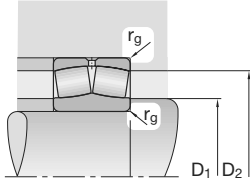

Load rating · Factor dyn. C	e	$F_a/F_r \leq e$ Y	$F_a/F_r > e$ Y	stat. C <sub>0</sub>	Y <sub>0</sub>	Limiting speed	Reference speed	Abutment dimensions		
								D <sub>1</sub> min mm	D <sub>2</sub> max	r <sub>g</sub> max
kN				kN		min <sup>-1</sup>				
430	0.22	3.04	4.53	585	2.97	4300	3000	128.8	171.2	2
430	0.22	3.04	4.53	585	2.97	4300	3000	128.8	171.2	2
540	0.29	2.3	3.42	800	2.25	3000	2200	128.8	171.2	2
630	0.28	2.39	3.56	800	2.34	3400	2400	131	189	2
630	0.28	2.39	3.56	800	2.34	3400	2400	131	189	2
780	0.37	1.84	2.74	1120	1.8	2200	1600	131	189	2
640	0.25	2.71	4.04	735	2.65	3400	2800	132	203	2.1
815	0.33	2.03	3.02	1020	1.98	2800	1900	132	203	2
815	0.33	2.03	3.02	1020	1.98	2800	1900	132	203	2
1080	0.33	2.06	3.06	1160	2.01	2600	2000	134	246	2.5
540	0.23	2.95	4.4	735	2.89	3600	2600	138.8	191.2	2
540	0.23	2.95	4.4	735	2.89	3600	2600	138.8	191.2	2
680	0.31	2.21	3.29	1020	2.16	2600	2000	138.8	191.2	2
680	0.28	2.45	3.64	900	2.39	3000	2200	141	199	2
680	0.28	2.45	3.64	900	2.39	3000	2200	141	199	2
815	0.34	1.96	2.92	1200	1.92	2200	1500	141	199	2
750	0.26	2.62	3.9	900	2.56	3000	2600	144	216	2.5
900	0.33	2.07	3.09	1140	2.03	2600	1800	144	216	2.5
900	0.33	2.07	3.09	1140	2.03	2600	1800	144	216	2.5
1250	0.33	2.06	3.06	1370	2.01	2400	1800	147	263	3

Spherical roller bearings 223..E1 are also available as a special design for vibratory stressing, e.g. 22324E1.T41A.

# FAG SPHERICAL ROLLER BEARINGS E1

## with cylindrical and tapered bores

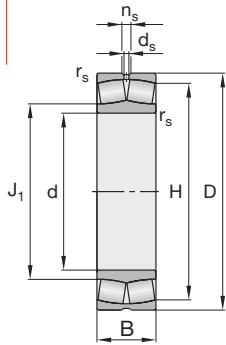

cylindrical bore

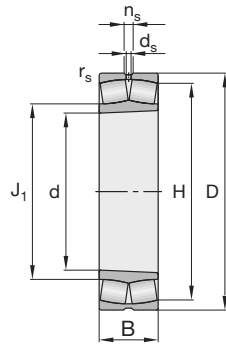

tapered bore

Shaft	Dimensions								Mass ≈ kg	Code Bearing FAG
	d	D	B	r <sub>s</sub> min	H ≈	J <sub>1</sub> ≈	n <sub>s</sub>	d <sub>s</sub>		
	mm									
<b>140</b>	140	210	53	2	192.3	155.4	9.5	4.8	6.04	<b>23028E1TVPB</b>
	140	210	53	2	192.3		9.5	4.8	6.45	<b>23028E1A.M</b>
	140	210	69	2	187.2	154.2	6.5	3.2	8.15	<b>24028E1TVPB</b>
	140	225	68	2.1	201	157.1	9.5	4.8	9.81	<b>23128E1TVPB</b>
	140	225	68	2.1	201		9.5	4.8	10.4	<b>23128E1A.M</b>
	140	225	85	2.1	194.4	157	9.5	4.8	12.8	<b>24128E1TVPB</b>
	140	250	68	3	223.4	164.9	12.2	6.3	14.2	<b>22228E1</b>
	140	250	88	3	216	162	12.2	6.3	17.7	<b>23228E1TVPB</b>
	140	250	88	3	216		12.2	6.3	18.3	<b>23228E1A.M</b>
	140	300	102	4	255.7	173.5	17.7	9.5	35.1	<b>22328E1</b>
<b>150</b>	150	225	56	2.1	206.3	166.6	9.5	4.8	7.63	<b>23030E1TVPB</b>
	150	225	56	2.1	206.3		9.5	4.8	7.83	<b>23030E1A.M</b>
	150	225	75	2.1	200.1	165.2	6.5	3.2	10.2	<b>24030E1TVPB</b>
	150	250	80	2.1	220.8	170.2	12.2	6.3	14.9	<b>23130E1TVPB</b>
	150	250	80	2.1	220.8		12.2	6.3	16.2	<b>23130E1A.M</b>
	150	270	73	3	240.8	177.9	15	8	18.2	<b>22230E1</b>
	150	270	96	3	232.6	174	12.2	6.3	22.9	<b>23230E1TVPB</b>
	150	270	96	3	232.6		12.2	6.3	23.7	<b>23230E1A.M</b>
	150	320	108	4	273.2	185.3	17.7	9.5	42.2	<b>22330E1</b>
<b>160</b>	160	240	60	2.1	219.9	177.5	12.2	6.3	8.97	<b>23032E1TVPB</b>
	160	240	60	2.1	219.9		12.2	6.3	9.71	<b>23032E1A.M</b>
	160	240	80	2.1	213.6	176	9.5	4.8	12.3	<b>24032E1TVPB</b>
	160	270	86	2.1	238.3	183.2	15	8	19.1	<b>23132E1TVPB</b>
	160	270	86	2.1	238.3		15	8	20	<b>23132E1A.M</b>

Spherical roller bearings E1 are also available with a tapered bore, e.g. 23130E1AK.M.

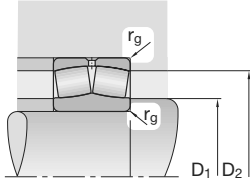

Load rating · Factor dyn. C	e	$F_a/F_r \leq e$ Y	$F_a/F_r > e$ Y	stat. C <sub>0</sub>	Y <sub>0</sub>	Limiting speed min <sup>-1</sup>	Reference speed	Abutment dimensions		
								D <sub>1</sub> min mm	D <sub>2</sub> max	r <sub>g</sub> max
570	0.22	3.07	4.57	800	3	3600	2400	148.8	201.2	2
570	0.22	3.07	4.57	800	3	3600	2400	148.8	201.2	2
720	0.29	2.33	3.47	1100	2.28	2600	1900	148.8	201.2	2
765	0.27	2.49	3.71	1020	2.43	2800	1900	152	213	2.1
765	0.27	2.49	3.71	1020	2.43	2800	1900	152	213	2.1
930	0.34	1.98	2.94	1370	1.93	2000	1300	152	213	2.1
880	0.25	2.67	3.97	1040	2.61	2400	2400	154	236	2.5
1080	0.33	2.04	3.04	1400	2	2400	1600	154	236	2.5
1080	0.33	2.04	3.04	1400	2	2400	1600	154	236	2.5
1460	0.34	2	2.98	1630	1.96	2200	1700	157	283	3
630	0.22	3.1	4.62	880	3.03	3400	2200	160.2	214.8	2.1
630	0.22	3.1	4.62	880	3.03	3400	2200	160.2	214.8	2.1
815	0.29	2.32	3.45	1250	2.26	2400	1700	160.2	214.8	2.1
1000	0.29	2.32	3.45	1320	2.26	2600	1700	162	238	2.1
1000	0.29	2.32	3.45	1320	2.26	2600	1700	162	238	2.1
1000	0.25	2.69	4	1220	2.63	2600	2000	164	256	2.5
1270	0.33	2.02	3	1660	1.97	2200	1400	164	256	2.5
1270	0.33	2.02	3	1660	1.97	2200	1400	164	256	2.5
1630	0.33	2.02	3	1860	1.97	2000	1500	167	303	3
720	0.22	3.1	4.62	1020	3.03	2800	2000	170.2	229.8	2.1
720	0.22	3.1	4.62	1020	3.03	2800	2000	170.2	229.8	2.1
915	0.29	2.3	3.42	1430	2.25	2200	1600	170.2	229.8	2.1
1160	0.29	2.32	3.45	1560	2.26	2400	1600	172	258	2.1
1160	0.29	2.32	3.45	1560	2.26	2400	1600	172	258	2.1

Spherical roller bearings 223..E1 are also available as a special design for vibratory stressing, e.g. 22330E1.T41A.

# FAG SPHERICAL ROLLER BEARINGS E1

## with cylindrical and tapered bores

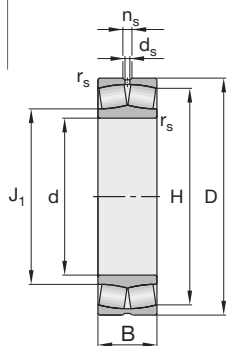

cylindrical bore

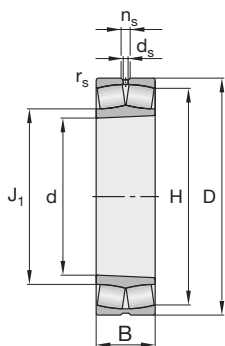

tapered bore

Shaft	Dimensions								Mass ≈ kg	Code Bearing FAG
	d	D	B	r <sub>s</sub> min	H ≈	J <sub>1</sub> ≈	n <sub>s</sub>	d <sub>s</sub>		
	mm									
	160	290	80	3	258.2	190.9	15	8	23.3	22232E1
	160	290	104	3	249.3	186.7	15	8	28.6	23232E1TVPB
	160	290	104	3	249.3		15	8	29.8	23232E1A.M
<b>170</b>	170	260	67	2.1	237.1	189.8	12.2	6.3	12.3	23034E1TVPB
	170	260	67	2.1	237.1		12.2	6.3	13	23034E1A.M
	170	280	88	2.1	248.1	193.4	15	8	20.7	23134E1TVPB
	170	280	88	2.1	248.1		15	8	22.1	23134E1A.M
	170	310	86	4	275.4	199.8	17.7	9.5	27.8	22234E1
	170	310	110	4	267.4	199.8	15	8	34.9	23234E1TVPB
	170	310	110	4	267.4		15	8	36.5	23234E1A.M
<b>180</b>	180	280	74	2.1	254.3	201.8	15	8	15.9	23036E1TVPB
	180	280	74	2.1	254.3		15	8	16.8	23036E1A.M
	180	300	96	3	264.8	204.1	15	8	27.3	23136E1TVPB
	180	300	96	3	264.8		15	8	26.1	23136E1A.M
	180	320	86	4	285.9	211.3	17.7	9.5	29.2	22236E1
	180	320	112	4	277.3	210.6	15	8	37.2	23236E1TVPB
	180	320	112	4	277.3		15	8	38.5	23236E1A.M
<b>190</b>	190	290	75	2.1	264.5	211.9	15	8	17.2	23038E1TVPB
	190	290	75	2.1	264.5		15	8	18.3	23038E1A.M
	190	320	104	3	281.6	217	15	8	32	23138E1TVPB
	190	320	104	3	281.6		15	8	33.9	23138E1A.M
<b>200</b>	200	310	82	2.1	281.6	223.4	15	8	21.5	23040E1TVPB
	200	310	82	2.1	281.6		15	8	22.1	23040E1A.M

Spherical roller bearings E1 are also available with a tapered bore, e.g. 23236E1AK.M.

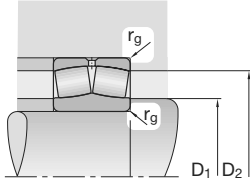

Load rating · Factor		$F_a/F_r \leq e$	$F_a/F_r > e$	stat. $C_0$	$Y_0$	Limiting speed	Reference speed	Abutment dimensions		
dyn. C	e							$Y$	$Y$	$C_0$
kN				kN		min <sup>-1</sup>				
1140	0.26	2.64	3.93	1400	2.58	2600	1900	174	276	2.5
1460	0.34	2	2.98	1900	1.96	2200	1300	174	276	2.5
1460	0.34	2	2.98	1900	1.96	2200	1300	174	276	2.5
880	0.23	2.98	4.44	1220	2.92	2600	1900	180.2	249.8	2.1
880	0.23	2.98	4.44	1220	2.92	2600	1900	180.2	249.8	2.1
1220	0.28	2.37	3.53	1700	2.32	2400	1500	182	268	2.1
1220	0.28	2.37	3.53	1700	2.32	2400	1500	182	268	2.1
1320	0.26	2.6	3.87	1560	2.54	2400	1800	187	293	3
1630	0.33	2.03	3.02	2160	1.98	2000	1200	187	293	3
1630	0.33	2.03	3.02	2160	1.98	2000	1200	187	293	3
1040	0.23	2.9	4.31	1460	2.83	2600	1800	190.2	269.8	2.1
1040	0.23	2.9	4.31	1460	2.83	2600	1800	190.2	269.8	2.1
1430	0.29	2.32	3.45	1960	2.26	2200	1400	194	286	2.5
1430	0.29	2.32	3.45	1960	2.26	2200	1400	194	286	2.5
1370	0.25	2.71	4.04	1660	2.65	2400	1700	197	303	3
1700	0.33	2.07	3.09	2360	2.03	2000	1100	197	303	3
1700	0.33	2.07	3.09	2360	2.03	2000	1100	197	303	3
1080	0.23	2.98	4.44	1560	2.92	2400	1700	200.2	279.8	2.1
1080	0.23	2.98	4.44	1560	2.92	2400	1700	200.2	279.8	2.1
1600	0.3	2.28	3.39	2240	2.23	2000	1300	204	306	2.5
1600	0.3	2.28	3.39	2240	2.23	2000	1300	204	306	2.5
1270	0.23	2.9	4.31	1800	2.83	2400	1600	210.2	299.8	2.1
1270	0.23	2.9	4.31	1800	2.83	2400	1600	210.2	299.8	2.1

**NOTES**

## NOTES

**NOTES**

## **FAG Kugelfischer Georg Schäfer AG**

Industrial Bearings and Services

Postfach 1260

D-97419 Schweinfurt

Georg-Schäfer-Straße 30

D-97421 Schweinfurt

Telefon +49 9721 91-0

Telefax +49 9721 91-3435

[www.fag.de](http://www.fag.de)

Every care has been taken to ensure the correctness of the information contained in this publication but no liability can be accepted for any errors or omissions.

We reserve the right to make changes in the interest of technical progress.

© by FAG 2002. This publication or parts thereof may not be reproduced without our permission.